



Micro Commercial Components

Micro Commercial Components
20736 Marilla Street Chatsworth
CA 91311
Phone: (818) 701-4933
Fax: (818) 701-4939

MMBT3906

PNP General Purpose Amplifier

Features

- Capable of 300mWatts of Power Dissipation
- Surface Mount SOT-23 Package
- Marking:2A
- Case Material:Molded Plastic. UL Flammability Classification Rating 94-0 and MSL Rating 1

Maximum Ratings

Symbol	Rating	Rating	Unit
V_{CEO}	Collector-Emitter Voltage	-40	V
V_{CBO}	Collector-Base Voltage	-40	V
V_{EBO}	Emitter-Base Voltage	-5.0	V
I_C	Collector Current, Continuous	-0.2	A
P_D	Power Dissipation	0.3	W
T_J	Operating Junction Temperature	-55 to +150	°C
T_{STG}	Storage Temperature	-55 to +150	°C

Electrical Characteristics @ 25°C Unless Otherwise Specified

Symbol	Parameter	Min	Max	Units
$V_{(BR)CEO}$	Collector-Emitter Breakdown Voltage* ($I_C=-1.0mA$, $I_B=0$)	-40		Vdc
$V_{(BR)CBO}$	Collector-Base Breakdown Voltage ($I_C=-10\mu A$, $I_E=0$)	-40		Vdc
$V_{(BR)EBO}$	Emitter-Base Breakdown Voltage ($I_E=-10\mu A$, $I_C=0$)	-5.0		Vdc
I_{CBO}	Collector cut-off Current ($V_{CB}=-40Vdc$, $I_E=0$)		-0.1	μA
I_{CEX}	Collector Cut-off Current ($V_{CE}=-30Vdc$, $V_{BE}=-3.0Vdc$)		-50	nA
I_{EBO}	Emitter cut-off Current ($V_{EB}=-5Vdc$, $I_C=0$)		-0.1	μA
h_{FE}	DC Current Gain* ($I_C=-10mA$, $V_{CE}=-1.0Vdc$) ($I_C=-50mA$, $V_{CE}=-1.0Vdc$) ($I_C=-100mA$, $V_{CE}=-1.0Vdc$)	100 60 30	300	
$V_{CE(sat)}$	Collector-Emitter Saturation Voltage ($I_C=-10mA$, $I_B=-1.0mA$) ($I_C=-50mA$, $I_B=-5.0mA$)		-0.25 -0.4	Vdc
$V_{BE(sat)}$	Base-Emitter Saturation Voltage ($I_C=-10mA$, $I_B=-1.0mA$) ($I_C=-50mA$, $I_B=-5.0mA$)	-0.65	-0.85 -0.95	Vdc
f_T	Current Gain-Bandwidth Product ($I_C=-10mA$, $V_{CE}=-20Vdc$, $f=100MHz$)	250		MHz

SWITCHING CHARACTERISTICS

Symbol	Parameter	Conditions	Max	Unit
t_d	Delay Time	($V_{CC}=-3.0Vdc$, $V_{BE}=-0.5Vdc$)	35	ns
t_r	Rise Time	($I_C=-10mA$, $I_{B1}=-1.0mA$)	35	ns
t_s	Storage Time	($V_{CC}=-3.0Vdc$, $I_C=-10mA$)	225	ns
t_f	Fall Time	($I_{B1}=I_{B2}=-1.0mA$)	75	ns

*Pulse Width $\leq 300\mu s$, Duty Cycle $\leq 2.0\%$

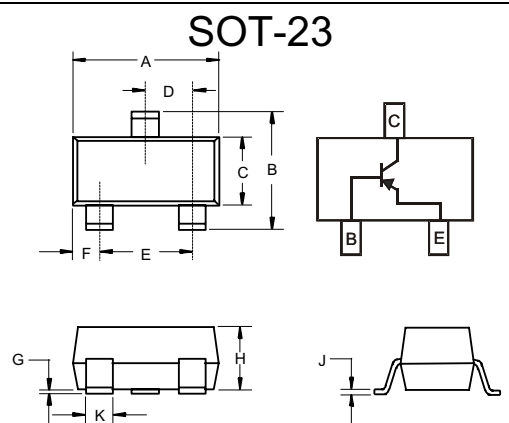

DIM	INCHES		MM		NOTE
	MIN	MAX	MIN	MAX	
A	.110	.120	2.80	3.04	
B	.083	.098	2.10	2.64	
C	.047	.055	1.20	1.40	
D	.035	.041	.89	1.03	
E	.070	.081	1.78	2.05	
F	.018	.024	.45	.60	
G	.0005	.0039	.013	.100	
H	.035	.044	.89	1.12	
J	.003	.007	.085	.180	
K	.015	.020	.37	.51	

Suggested Solder Pad Layout

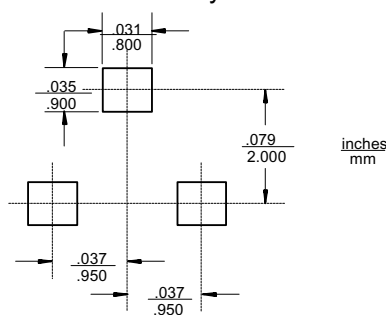

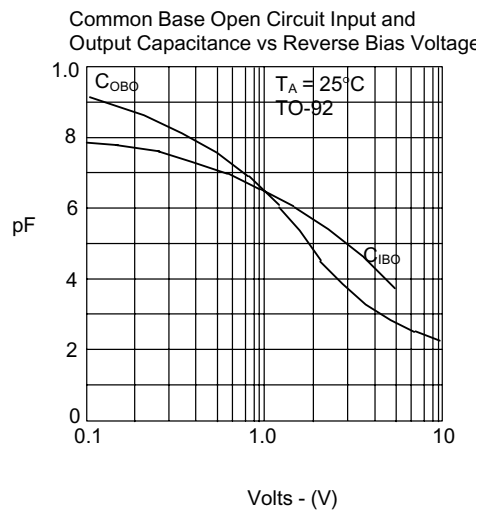
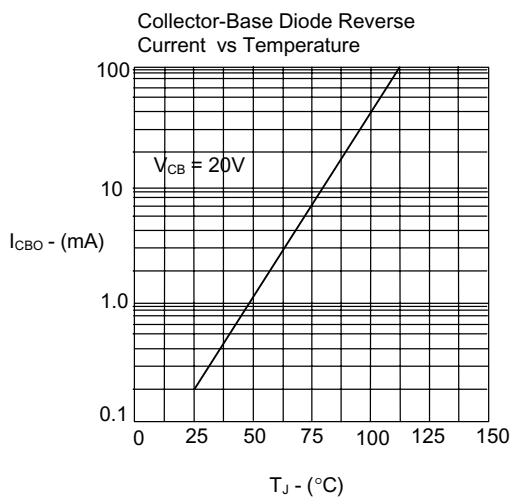
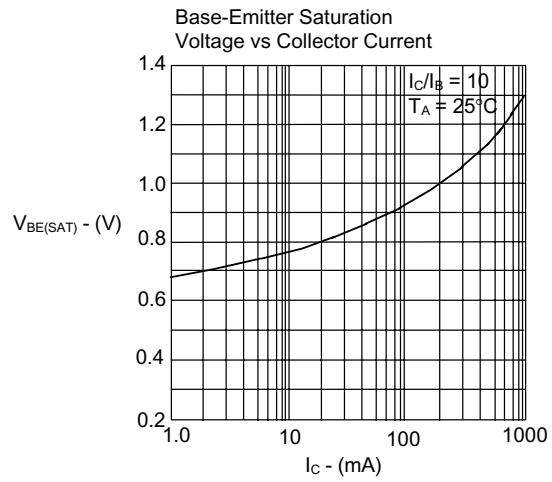
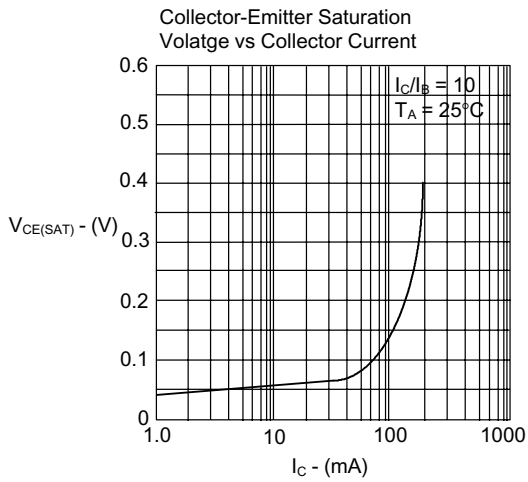
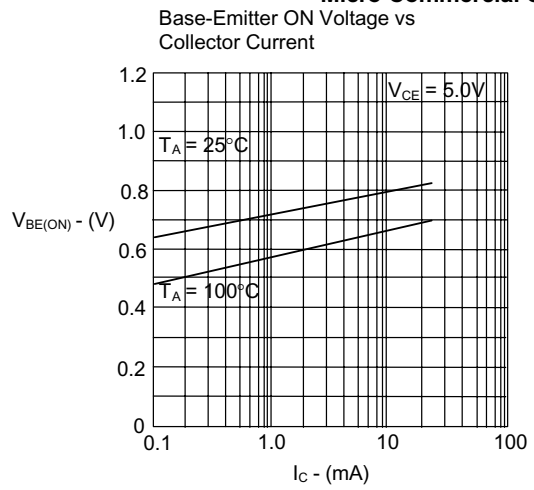
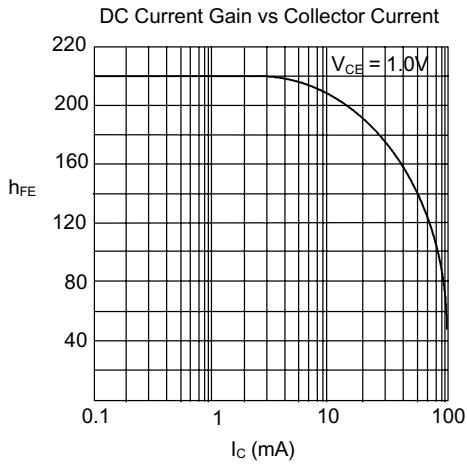

MMBT3906

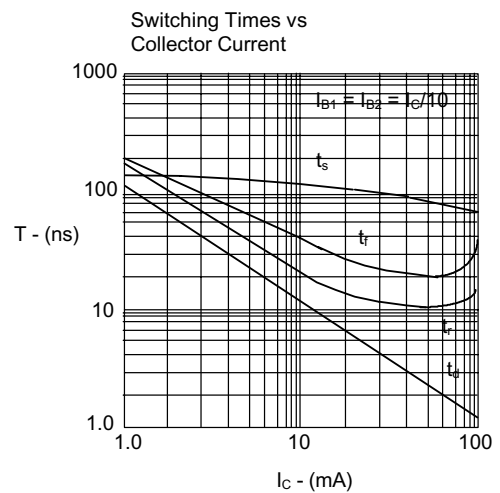
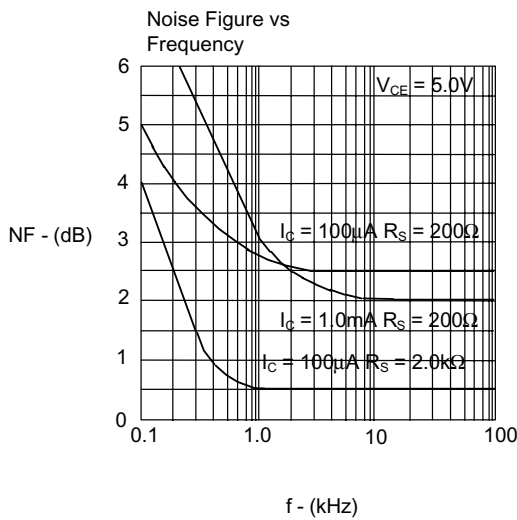
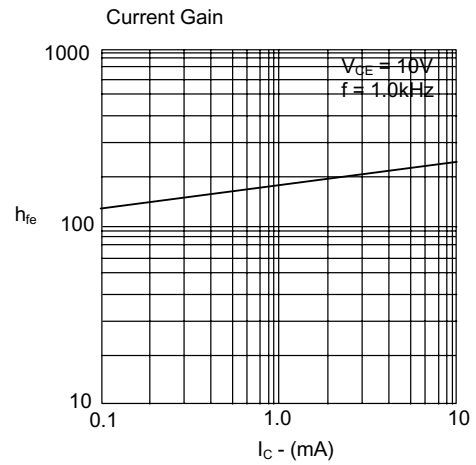
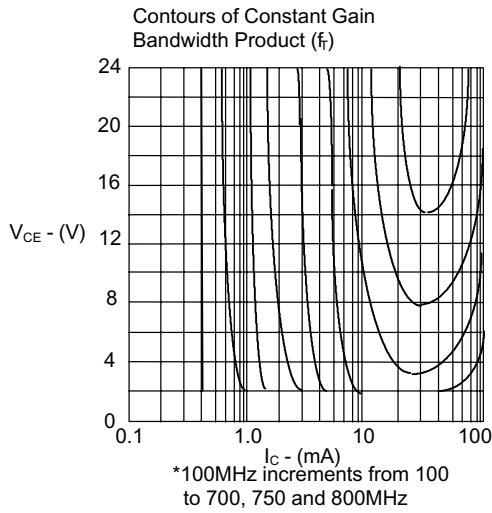
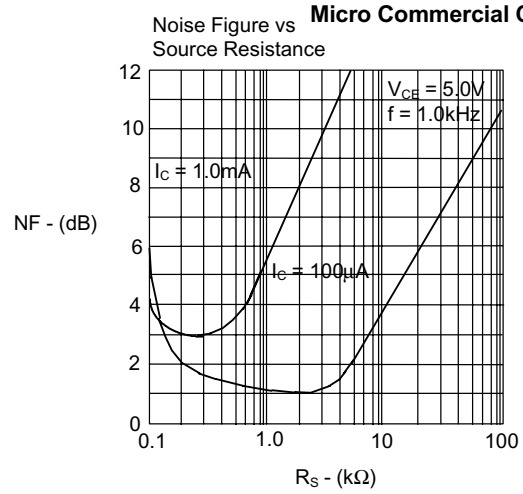
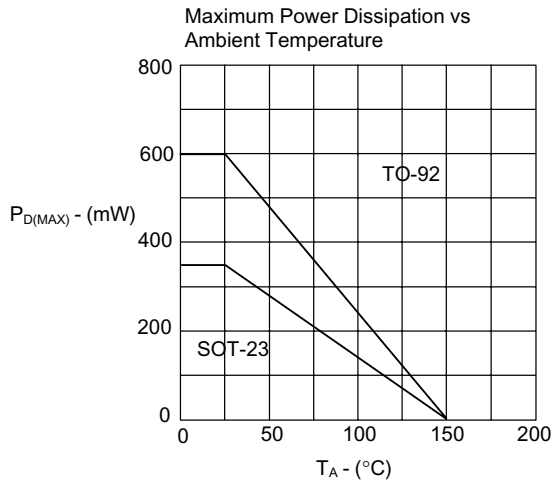

MMBT3906

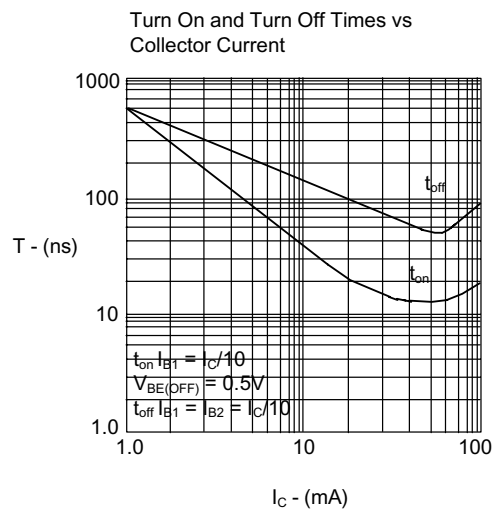
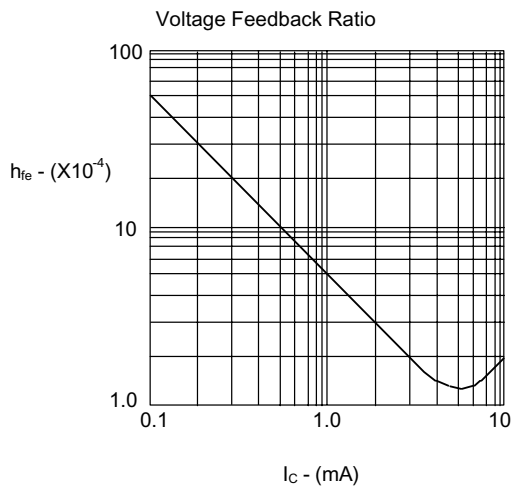
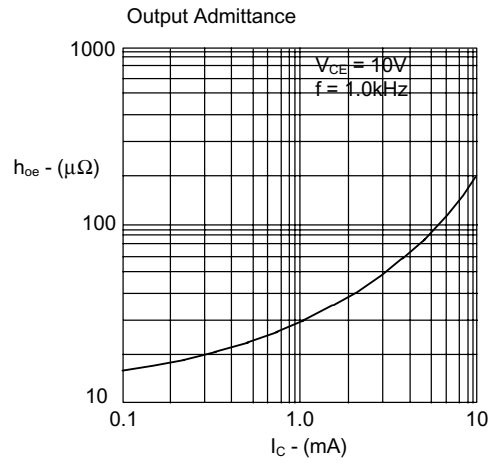
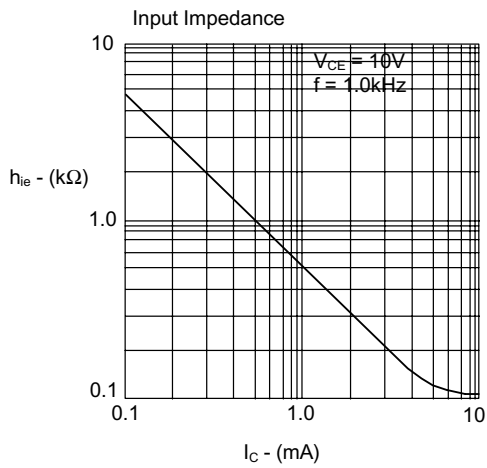



Micro Commercial Components

Ordering Information

Device	Packing
(Part Number)-TP	Tape&Reel;3Kpcs/Reel

IMPORTANT NOTICE

Micro Commercial Components Corp. reserves the right to make changes without further notice to any product herein to make corrections, modifications, enhancements, improvements, or other changes. *Micro Commercial Components Corp.* does not assume any liability arising out of the application or use of any product described herein; neither does it convey any license under its patent rights, nor the rights of others. The user of products in such applications shall assume all risks of such use and will agree to hold *Micro Commercial Components Corp.* and all the companies whose products are represented on our website, harmless against all damages.

APPLICATIONS DISCLAIMER

Products offer by *Micro Commercial Components Corp.* are not intended for use in Medical, Aerospace or Military Applications.